



Underwater Archaeological Impact Assessment (UAIA) Morrison's Island Flood Alleviation Works

Lower Lee (Cork City) Drainage Scheme

16D0053, 16R0079

DRAFT FOR REVIEW

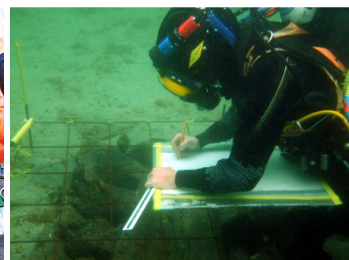
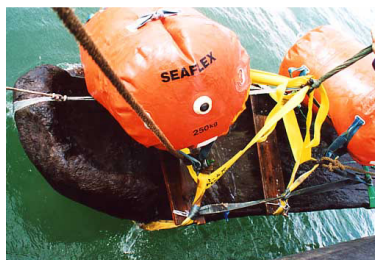
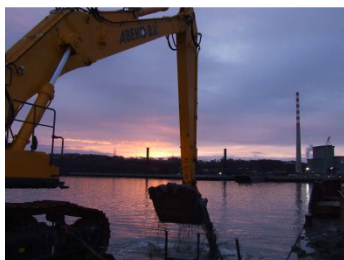



**Underwater Archaeological Impact Assessment (UAIA)
Morrison's Island Flood Alleviation Works**

Lower Lee (Cork City) Drainage Scheme

16D0053, 16R0079

DRAFT FOR REVIEW

11th November 2017

Project Director

Rex Bangerter MA

ADCO, Beverley Studios, Church Terrace, Bray, Co. Wicklow

www.adco-ie.com

CONTENTS

SUMMARY	1
LIST OF FIGURES	2
LIST OF PLATES	3
LIST OF ABBREVIATIONS	5
1.0 INTRODUCTION	6
2.0 PROPOSED FLOOD ALLEVIATION WORKS	6
2.1 quay Wall Remedial works	7
2.2 Flood Defence Walls	7
2.3 Pumping Stations	7
2.4 Drainage and Finishes	7
3.0 CARTOGRAPHIC INFORMATION	8
3.1 Eighteenth-century Mapping	9
3.2 Nineteenth-century Mapping	10
3.3 Conclusion	12
4.0 SURVEY METHODOLOGY	13
4.1 Terminology	14
5.0 ARCHAEOLOGICAL ASSESSMENT	14
5.1 River Topography	14
5.2 Visual Survey and Assessment	15
5.3 Conclusion	18
6.0 PROPOSED IMPACTS	18
7.0 MITIGATION	19
8.0 RECOMMENDATIONS	20
8.1 Pre-construction Phase Measures	20
8.2 Construction Phase Measures	20
9.0 ACKNOWLEDGEMENTS	21
FIGURES AND PLATES	

EXECUTIVE SUMMARY

The Archaeological Diving Company Ltd (ADCO) was appointed by Ryan Hanley, Consulting Engineers on behalf of the Office of Public Works (OPW), to provide an Underwater Archaeological Impact Assessment (UAIA) report for the proposed Morrison's Island Flood Alleviation Works. These works form part of the wider River Lee (Cork City) Drainage Scheme and are subject to advance planning, requiring a separate archaeological assessment report to be submitted as part of that process.

The proposed flood alleviation works comprise the insertion of two flood defence walls, road realignment, provision of parking spaces and associated footpaths, and alterations to the surface drainage and underground services currently in place. This work will involve the raising of existing defence levels to provide effective and continuous flood defence along the north bank of the South Channel at Morrison's Island. A comprehensive UAIA was carried by ADCO in June 2016 as part of the pre-planning requirement for the Lower Lee (Cork City) Drainage Scheme. This work informed the Cultural Heritage chapter of the project Environmental Impact Statement, prepared in partnership with John Cronin and Associates.¹ The current project design at Morrison's Island remains generally unchanged to that presented in the EIS.

The following report presents the observations and findings from the UAIA with specific regard to the proposed flood alleviation works Morrison's Island. This includes a detailed account of riverbed topography, the existing riverside environment, and any features identified as part of the non-disturbance underwater/ waded inspection of the river channel and its attendant quayside structures.

Five features known or previously unrecorded features of historic/ industrial archaeological significance have been identified for the area under assessment; Features F001 (Father Matthew Quay), F002 (Morrison's Quay), F002a (Arched Culvert), F003 (Parliament Bridge) and F004 (Parnell Bridge). These features are discussed in Section 5 of this report. Impact assessment and proposed mitigation is presented in Sections 6.0 and 7.0 respectively.

This report recommends that further archaeological work in advance of construction is not required. However, it is recommended that archaeological monitoring of ground disturbances during construction be undertaken, with the proviso to resolve fully any archaeological material observed at that point. The recommendations of this report are subject to the approval of the National Monuments Service at the Department of Culture, Heritage, and the Gaeltacht (DCHG).

¹ Rex Bangerter, 'Underwater Archaeological Impact Assessment, Lower Lee (Cork City) Drainage Scheme, 16D0053, 16R0079', ADCO, unpublished report, December 2016.

LIST OF FIGURES

- Figure 1: Extract from OS (Discovery Series) Map showing location and extent of ADCO Survey Area along the River Lee at Morrison's Island, cork City.
- Figure 2: John Rocque's Map of 1759; *A Survey of the City and Suburbs of Cork*.
- Figure 3: John Rocque's Map of 1773, *A Survey of the City and Suburbs of Cork*.
- Figure 4: Extract from a *Plan of the City and Suburbs of Cork, according to the latest Improvements*, by William Beauford, 1801.
- Figure 5: Extract from a *Plan of the City and Suburbs of Cork*, surveyed and drawn by Thomas Holt, 1832.
- Figure 6: Extract from OS Frist Edition (1841) Map showing Morrison's Island with approximate location of proposed Flood Alleviation Works superimposed.
- Figure 7: Extract from OS 25-inch (1899) Map showing Morrison's Island with approximate location of proposed Flood Alleviation Works superimposed.
- Figure 8: Location and extent of ADCO Survey Area at Morrison's Island, South Channel of the River Lee, with selected plate locations superimposed.
- Figure 9: A) Elevation showing masonry and recessed wrought iron ladder access to river, Farther Matthew Quay.
B) Example of consolidation measures [Type 2] used along base of quay wall.
- Figure 10: A) Scaled isometric view of quay wall along Morrison's Quay, detailing one of the greenheart timber fenders that are present along much of its extent.
B) Aerial view of topmost part of timber fender.
- Figure 11: Scaled isometric views at two locations along Farther Matthew Quay, as indicated in Figure 8.
- Figure 12: Scaled isometric view showing quay wall and set of masonry river-access steps forming part of Morrison's Quay.

LIST OF PLATES

- Plate 1: Nineteenth-century photograph showing downstream side of Morrison's Quay and the newly reclaimed South Mall area/
- Plate 2: Underwater shot showing riverbed downstream of Parliament Bridge.
- Plate 3: Underwater shot showing riverbed downstream of Trinity Footbridge.
- Plate 4: Deposition on north side of channel, downstream of Trinity Footbridge.
- Plate 5: Northeast-facing view along upstream side of Morrison's Quay.
- Plate 6: West-facing view of the South Chanel showing upstream side of Trinity Footbridge.
- Plate 7: Southwest-facing view of the river channel at Trinity Footbridge.
- Plate 8: Northeast-facing view showing the fabric of the quay structure forming Father Matthew Quay and Morrison's Quay.
- Plate 9: Detail shot of masonry used to construct Morrison's Quay.
- Plate 10: Northwest-facing view Morrison's Quay showing timber piles (Type 1) and concrete used to underpin sections of Father Matthew Quay/Morrison's Quay.
- Plate 11: Example shot of timber piles (Type 1) used to underpin section of Father Matthew Quay/Morrison's Quay.
- Plate 12: Example shot of timber piles set flush to the quay wall along Father Matthew Quay.
- Plate 13: Example shot of timber fenders used along Father Matthew Quay/Morrison's Quay.
- Plate 14: Northwest-facing view along eastern half of Morrison's Quay; taken at Low Water.
- Plate 15: East-facing view along western half of Morrison's Quay; taken at Low Water.
- Plate 16: Example shot showing the top components of the timber fenders used along Father Matthew Quay/Morrison's Quay.
- Plate 17: Example shot showing top-view of timber fenders used along Father Matthew Quay/Morrison's Quay.
- Plate 18: Example shot showing one of three identical sets of river-access steps located along Father Matthew Quay/Morrison's Quay.
- Plate 19: Example shot showing one of three identical sets of river-access steps located along Father Matthew Quay/Morrison's Quay.
- Plate 20: Example shot showing one of the smaller rectangular drain features located along Father Matthew Quay/Morrison's Quay.
- Plate 21: Example shot showing one of the larger rectangular drain features located along Father Matthew Quay/Morrison's Quay.

- Plate 22: North-facing view of an ached-culvert located Morrison's Quay.
- Plate 23: Example shot of smaller type of iron mooring hoop associated with the river-access steps along Father Matthew Quay/Morrison's Quay.
- Plate 24: Example shot of larger type of iron mooring hoop located along Father Matthew Quay/Morrison's Quay.
- Plate 25: South-facing view of cast-iron mooring bollard located towards the southern end of Morrison's Quay.
- Plate 26: Example shot of one of the mooring bollards located at Lapp's Quay.
- Plate 27: West-facing view of downstream façade of Parliament Bridge.
- Plate 28: West-facing view timber shuttering and bridge foundations located on north side of archway at Parliament Bridge.
- Plate 29: Drawing from the Illustrated London News (1843) depicting the original Anglesea Bridge of the 1830s.
- Plate 30: Nineteenth-century photograph of the original Anglesea Bridge.
- Plate 31: Nineteenth-century engineer's drawing of Anglesea Swivel-Bridge.
- Plate 32: Twentieth-century photograph of the iron swivel-bridge that replaced (1882) the earlier masonry structure forming Anglesea Bridge.
- Plate 33: East-facing view remains of southern bridge abutment beneath the existing Parnell Bridge.
- Plate 34: South-facing view showing masonry steps built as part of the original Parnell Bridge.
- Plate 35: Northeast-facing view showing masonry forming a bridge abutment on the north side of the channel, located beneath the original Parnell Bridge.
- Plate 36: North-facing view upstream side of the modern Parnell Bridge built in 1971.

LIST OF ABBREVIATIONS

ADCO	The Archaeological Diving Company Ltd
ACA	Architectural Conservation Area
CFRAM	Catchment Flood Risk Assessment and Management
DAHRRGA	Department of Arts, Heritage, Regional, Rural and Gaeltacht Affairs
DAU	Development Applications Unit
EIS	Environmental Impact Statement
E	Easting
N	Northing
NGR	National Grid Reference
NIAH	National Inventory of Architectural Heritage
OPW	Office of Public Works
RMP	Record of Monuments and Places
RPS	Record of Protected Structures
UAU	The Underwater Archaeology Unit
UAIA	Underwater Archaeological Impact Assessment

1.0 INTRODUCTION

The Archaeological Diving Company Ltd. was appointed by Ryan Hanley, consulting engineers on behalf of the Office of Public Works (OPW), to undertake an Underwater Archaeological Impact Assessment (UAIA) along a c. 7km section of the River Lee as part of the Lower Lee (Cork City) Drainage Scheme. This work was carried out in accordance with the terms of Section 5 of the National Monuments Act (2004 Amendment) by a team of underwater archaeologists and a certified surveyor between 7th and 16th of June 2016, under licence from the DCHG (formerly DAHRRGA); licence numbers 16D0053 and 16R0079. The subsequent EIS contribution was finalised in December 2016.

The observations and findings gathered as part of the above endeavour, relating to the two historic quays forming the riverside at Morrison's Island, are now presented as part of the proposed Morrison's Island Flood Alleviation Works project; this component of the scheme being subject to an advance contract that requires a separate planning proposal to that of the Lower Lee Drainage Scheme.

Systematic visual inspection of the in-water extent of the proposed works at Morrison's Island has been undertaken. The archaeological assessment sought to record riverbed and bankside topography, assess the potential of riverbed deposits to retain archaeological material, and identify any features/structures of archaeological or historic significance that are present.

The following report presents the findings from the UAIA and assesses the potential level of impact arising from the development along Morrison's Island; providing a set of specific mitigation measures relating to each feature identified as part of the assessment. The UAIA was primarily concerned with in-field assessment. A desktop study providing a comprehensive outline of the archaeological and historical background of the assessment area has been completed separately by John Cronin and Associates.²

2.0 PROPOSED FLOOD ALLEVIATION WORKS

The required flood defence levels have been provided as an output of the Lee Catchment Flood Risk Assessment and Management Study (CFRAMS). The defence level corresponds to the modelled 1:200 year combined event (tidal region), and 1:100 year flow (fluvial zone) taking account of climate change modelling and freeboard. These conditions represent the requirements of the EU floods directive which has been transposed into Irish law, Statutory Instrument 122 of 2010.

The proposed works at Morrison's Island include the provision of flood defences along the south channel of the River Lee, located between Parnell Bridge and Parliament Bridge. The works comprise

² John Cronin & Associates, 'Morrison's Island, Cork City: Archaeological and Architectural Heritage Impact Assessment', November 2017.

an architecturally designed quayside parapet wall (flood defence wall) and railing, designed to reflect and respect the historic bollards which historically adorned these quays; while maximising the view of the river and protecting against extreme tidal flooding. The proposed flood alleviation works at Morrison's Island have been itemised as follows:

2.1 Quay Wall Remedial Works

- Scaffolding and temporary propping to be erected on the wet site of the quay wall as required.
- Construction of a new reinforced concrete backing wall to be carried out in short lengths (c. 5m). This is to commence with excavation of existing backfill material.
- The concrete backing wall is to be poured in short lifts to minimise pressure on the existing quay wall.
- New quay wall back-drainage to be installed.
- Backfill to top of existing quay wall.
- All joints to be raked out, cleaned and repointed by hand.
- Face of existing quay to be thoroughly cleaned with high pressure water jetting (all dirt and marine growth to be completely removed).
- Grouting of foundation zone and existing quay wall to begin.
- Quay wall is to be gravity grouted initially, through holes drilled c/c 2m down through the centre of the wall.
- When the wall gravity grouting has set, the wall and foundation zone to be pressure grouted; holes drilled c/c 1m through the body of the wall, down into the foundation zone.
- Galvanised reinforcement stitching bars to be installed and grouted into the cored holes.

2.2 Flood Defence Walls

- Remove existing railings and parapet walls
- Dowel connections to be drilled in to RC backing wall to ensure connection of Flood wall to backing wall.
- Tie back rebar to be fixed.
- Shuttering for base of L-Wall to be fixed
- Base of L-Wall poured
- Upstand of L-wall poured

2.3 Pumping Stations

- Pumping stations to be installed as required. The footprint of the pumping station will be set out. Where the proposed excavation is located in a paved area, the pavement will be saw cut. The excavation will take place to the required depth. Sheet piling will likely be required in order to facilitate construction of deep excavations in an urban area.
- Excavated material unsuitable for use as backfill material will be disposed of to an approved waste management facility. Lean mix concrete blinding will be placed, followed by formwork and steel fixing. Once concrete has been poured and has cured, the formwork will be stripped and the area outside the pumping station will be backfilled.
- Excavations in paved areas will be backfilled with granular material and reinstated to their original condition.
- Mechanical and electrical fit out of pumping stations will take place following backfilling.

2.4 Drainage and Finishes

- Place new surfacing drainage
- Road surface to be laid
- General finishes to structures, junctions, traffic lights, signage, road markings, bike share station etc.
- Installation of Stainless steel railing and Wire Rope system
- Road opened to full traffic

3.0 CARTOGRAPHIC INFORMATION

Evidence of human activity within the environs of present-day Cork City can be found throughout the prehistoric period, with this early activity principally surrounding the estuarine and harbour areas located to the east of the city. However, the development of a tangible settlement located on the floodplains of the River Lee can be traced to the Hiberno-Vikings, settling on the South Island, and the later Anglo-Norman expansion of that settlement; forming a medieval walled-city that encompassed both South and North Islands. While the city's core has its origins in the medieval period, it is the Industrial period that has exercised the greatest influence on the settlement's development, shaping the conurbation and producing much of what currently defines the city's modern urban space. In particular, the River Lee has witnessed successive alterations/adaptations from the mid-1700s onward, facilitating the development of extractive and manufacturing industries, the enhanced transportation of goods (both to and from the city), and the establishment of public utilities to supply the municipality. Not surprisingly, it is Industrial Period (1750-1930) features that are best represented within the present-day river environment at Morrison's Island.

ADCO's scope of work is primarily focused on the presentation of the findings from the on-site survey and wider discussion of the receiving environment at Morrison's Island has been prepared as part of the archaeological/architectural heritage assessment for the proposed development. What follows is an examination of a series of historic maps that show the development of the waterfront area surrounding Morrison's Island from the eighteenth-century onwards. A number of historic maps have been selected for discussion in the current report. Examination of these cartographic sources provides a direct context for the in-field work, allowing improvements to the waterway infrastructure to be charted over time. The following maps have been included for discussion (Figures 2-7):³

- *A Survey of the City and Suburbs of Cork* by John Rocque, 1759.
- *A Survey of the City and Suburbs of Cork* by John Rocque, 1773.
- *Plan of the City and Suburbs of Cork, according to the latest Improvements*, by William Beauford, 1801.
- *Plan of the City and Suburbs of Cork*, surveyed and drawn by Thomas Holt, 1832.
- Ordnance Survey (OS) 6-inch First Edition Map of 1841.
- Ordnance Survey (OS) 25-inch Edition Map of 1889-1900.

Specific cartographic changes/features from these maps have been highlighted and the corresponding item numbers referenced in the report text (Map Items 1-25), allowing for improved cross-referencing with the accompanying figures (Figures 2-7). In addition to the examination of the above maps, the proposed extent of flood defence works have been superimposed on OS 6-inch First Edition (1841) and later 25-inch (1899-1900) edition mapping to allow reliable comparison between the proposed works and the historic landscape depicted on those maps (Figures 6-7).

³ Maps accessed from the OSi Historic Map Archive at www.osi.ie and the Cork City Archives at www.corkpastandpresent.ie.

3.1 Eighteenth-century mapping; Figures 2-3

A number of maps depicting Cork City were produced in the eighteenth-century; however, it is those compiled by John Rocque in 1759 and 1773 that provide the greatest detail (Figures 2-3, respectively).

Rocque's 1759-map shows extensive development of the city's suburbs to the north and south, along with wide-scale reclamation of the estuary to the east and west of the original conurbation (Figure 2). This includes the reclamation of '*Hammond's Marsh*' on the western side of the city (as far west as '*Reily's Marsh*') and the development of land to the east of the city's original south island; an area annotated '*Bonding Green*' on the late seventeenth-century mapping. It is also the first time that the city's street names have been extensively included.

The North Gate and South Gate Bridges remain the only crossing points depicted along the north and south channels remain. These bridges were originally of timber construction, later replaced with masonry bridges in the early eighteenth-century; the timber structures having been swept away on two occasions previously in the flood events of 1630 and 1639.

However, it is the city's mercantile development that should be considered one of the most notable aspects of Roque's map, highlighted by the establishment of a series of quaysides, predominantly along the river's northern channel, to facilitate maritime trade. In contrast, the South Channel and outlying suburbs appear less advanced, with development focused along the southern approach to the city (Bandon Road leading onto Barrack Street). In addition, the area of marshland that later comprises Morrison's Island remains only partially reclaimed at this time; the northern limit of the island having been built upon, while with the area to the south is depicted as marshy ground, annotated *Dunbar's Marsh* (Map Item 1).

A substantial quayside, annotated '*Sullivan's Quay*', has been established on the south of the waterway, downstream of South Gate Bridge. Two further quays, located opposite Sullivan's Quay, are also shown extending northward into the city; running along a waterway that originally defined the eastern limits of city. These structures, named Post Office Quay and Tuckey's Quay, occupied the present day extent of the Grand Parade and were linked to the southern extent of Calvill's Quay. Two bridge structures (Daunt's Bridge and Tuckey's Bridge) cross the waterway, providing access between The Mall to the east and the aforementioned quaysides to the west; Daunt's Bridge being located at the northern extent of Tuckey's Quay (present day Duant's Square) and the other unnamed bridge (Tuckey's Bridge) at the northern limit of Post Office Quay.

Roque's 1773-map depicts only minor changes to settlement extent, showing a cityscape and street pattern that remains largely unchanged to that presented on his earlier map of 1759 (Figure 3). However, a number of changes are shown, most notably the reclamation of Dunbar's Marsh (Morrison's Island) and the insertion of a new bridge (Parliament Bridge), crossing the south channel

between Sullivan's Quay and the western limit of Morrison's Island (present day Father Matthew Quay) (Items 2-3). Parliament Bridge was built in 1760s and is shown on Roque's map to a similar scale as South Gate Bridge, with three in-water piers indicated. The structure was later replaced by the current bridge in 1804.

Continued development on the southern side of the channel is also evident, along the present day extent of George's Quay, as far as Thomas Street (now White Street) (Item 4). In addition, Tuckey's Quay has now been culverted and marks the first of the city's inner quays to be reclaimed (Item 5).

3.2 Nineteenth-century mapping; Figures 4-7

Examination of the nineteenth-century maps shows continued mercantile growth and the successive expansion of the city, particularly along the eastern and western extremities of the settlement (Plate 1). These changes are linked to the industrial development of the city, a process that was begun in the latter part of the seventeenth-century. Maps by William Beauford (1801) and Thomas Holt (1832) provide insight into the early part of that process (Figures 4-5), the later OS First Edition (1841) and Second Edition (1889-1900) maps providing a closer account of the settlement's transition to the modern-day (Figure 6-7). The main developmental changes depicted on these maps, viewed in relation to Morrison's Island at the surrounding river-scape are presented below.

Beauford's Map of 1801 depicts further improvements to Morrison's Island, now shown to be delineated by three clearly defined quay structures, namely; Charlotte's Quay (present Day Father Mathew Quay) to the south, Morrison's Quay to the east, and Lawton's Quay to the north (running parallel to the South Mall) (Item 6). The former site of Dunscomb's Marsh, an area of marshland located at the downstream (eastern) confluence of the two river channels, is now depicted as developed land and annotated '*Lapp's Island*' (Item 7). The island is separated from the main conurbation by a narrow waterway, running between Cold Harbour Quay (to the west) and Nelson's Quay (to the east); an un-named bridge/culvert provides access between the island and Georges Street, the present day site of Oliver Plunkett Street.

The continued development of scrublands behind Georges Quay is also evident, along with marshy-ground further to the southeast, near the western limit of Allen's Marsh. In addition, the upstream terminus of a Navigation Wall, annotated *New Wall*, is depicted a short distance to the east (Item 8). This structure delineates the southern side of the channel and bounds the northern limit of Tooker Marsh, leading into Allen's Marsh. The wall was commissioned by the Cork Corporation in 1760 and was designed to limit the silting-up of the main channel, allowing for greater shipping capacity along the main channel. The structure was later used as a retaining-wall for river dredging works undertaken in the mid-1800s. The wall extended several kilometres to the east, much of this structure now forming a The Marina promenade.

Holt's map of 1832 is the first map to record Great Georges Street (now renamed Washington Street), which was newly constructed between the Grand Parade and the '*Western Entrance*' (now the Western Road) (Item 9). Other significant changes to the streetscape are also depicted for the first time; the city's remaining inner-quays having been reclaimed to form new thoroughfares within the city (Items 10-13): Newham's Quay being reclaimed to form Corn Market Street; the site of the original Lavitt's Quay reclaimed to form Nelson Place, later renamed Emmett Place; the site of Cold Harbour and Nelson's Quays reclaimed to form Warren's Pace, later renamed Custom House Street; and Lawton's Quay, forming the north side of Morrison's Island, being reclaimed and subsumed into the South Mall (Plate 1).

The reclamation of land along the downstream sections of the north and south channels is also evident. To the south of Morrison's Island, the map shows the newly established corn exchange (annotated '*Corn Market*') on lands that once formed Allan's Marsh (Item 14). A new quayside was included as part of this development, named '*Union Island*' (later Union Quay), running along the southern side of the channel (opposite Morrison's Quay). The upstream limit of a new Navigation Wall, constructed to improve access for shipping as it approached the city, is also shown on this map. The structure's upstream terminus is depicted a short distance to the east of the aforementioned corn exchange, at the present-day location of Albert Quay East.

A new bridge, '*Anglesea Bridge*' (built 1830), crosses the South Channel, providing access between the corn exchange and the Lapp's Island (Item 15). The bridge is positioned at the eastern terminus of Union Island [Quay] to the south, leading onto Warren's Place to the north. In addition, a new custom's house is shown at the tip of Lapp's Island (Item 16).

The map area extracted from the OS First Edition (1841) and 25-inch Edition (1889-1900) map archive depicts the north and south channels as they flow past the Centre, North Centre, and South Centre Wards to a point immediately downstream of the Customs House (Lapp's Island) (Figures 6-7). The OS First Edition Map shows a riverside environment that is largely similar to that observed for present-day; many of the quayside structures remaining unaffected by modern intervention (Figure 6). Perhaps the most notable contrast between this mapping and the present day environment is the twentieth-century development of the city's bridge infrastructure; a series of subsequent bridges now spanning the north and south channels.

Three bridges are depicted for the South Channel and include South Gate Bridge, Parliament Bridge, and Anglesea Bridge (Items 17-19). Today, four bridge additions are present within this map-area and include: the Nano Nagle footbridge (built 1985), Parnell Bridge (1971), Clontarf Bridge (built 1911), and Eamon De Velera Bridge (built 1984).

The north side of the South Channel is delineated by three quays, Charlotte Quay (now Father Matthew Quay), Morrison's Quay, and Lapp's Quay, while the south side is delineated by five quay

structures: Franches Quay, Sullivan's Quay, George's Quay, Union Quay, and Albert Quay. Vitoria Quay (now Kennedy Quay), built downstream of Albert Quay, was a latter addition (built in the late 1880s) and is shown on the OS 25-inch mapping. The lands behind Albert Quay, encompassing the Corn Exchange, appear further developed and a '*Gas Works*' and '*Lime Works*' are also depicted at that location; the former works being established by the General Gas Company in 1826 (Item 20).

The OS 25-inch map of this area depicts significant development to the city's transport infrastructure with the addition of a city-centre tramline which opened in 1898 (Figure 7). The tramway is shown running from Albert Quay, across Parnell Bridge, and along the South Mall (Item 21). This line is linked via Robert Street to a tramline travelling northward from St. Patrick's Street, crossing St. Patricks Bridge to travel either eastward along King Street (now McCurtain Street) or westward along Coburg Street. The South Mall tramline is also linked to the Grand Parade and Georges Street (now Washington Street) via Marlborough Street and St. Patrick's Street. A large Railway Terminus is located immediately west of the Corn Market, behind Albert Quay (Item 22). The station accommodates the aforementioned tramway and the Cork, Blackrock and Passage Railway, which opened in 1850. An '*Electric Power Station*' is also shown as part of the station complex and most likely powered the tramway system.

Development along the South Channel includes the addition of timber yards, the '*Cork Porter Brewery*' (Item 23), the '*Vulcan Iron Works*' on Union Quay (Item 24), and '*Marina Mills*' (incorporating Furlong's Mill) on Victoria Quay, the present day site of Kennedy Quay. However, one the most notable developments on the South Channel is the replacement of Anglesea Bridge with Parnell Bridge; a three-span swing-bridge commissioned by the Cork Corporation and completed in 1882 (Item 25). This bridge was later replaced in 1971 by the existing structure, also named Parnell Bridge. The 25-inch map also depicts two jetties protruding into the river, from the northern side of the channel (Morrison's Quay/ Lapp's Quay), on the upstream and downstream sides of Parnell Bridge. These structures measure c. 20m in length and are both annotated '*Landing Stage*'.

A final cartographic feature of note is the inclusion of '*Mooring Posts*' on the 25-inch map; a series of dots representing mooring positions being indicated along seven of the city's quaysides, including Lapp's Quay. A number of these moorings still survive today, positioned along Penrose Quay, Lapp's Quay, and Albert Quay.

3.3 Conclusion

The River Lee has played a defining role in the development of Cork City from its medieval origins, as a settlement occupying the north and south islands of the river estuary, through to its emergence as an industrialised conurbation in the nineteenth-century. Cartographic information provides useful insight into that development, charting the city's topography over time. The establishment of the city's many quayside areas from the seventeenth-century onward emphasises the river's importance to maritime trade. Reclamation of marshland areas allowed the city-centre to expand on its east and

west sides and provided additional lands for the emerging suburbs located to the north and south. Continued bridge building from the mid-1700s corresponded with the growth of these outlying suburbs; the provision of bridge infrastructure to connect with new areas of settlement proving vital to the city's advancement. The increased industrialisation of the nineteenth-century is represented by the establishment of public utilities within the city, the presence of intensified manufacturing (mills, distilleries, breweries, foundries, timber yards, etc.), and a developing city-wide transport infrastructure.

4.0 SURVEY METHODOLOGY

The survey was designed to provide a thorough baseline study of the archaeological risk for the river area under assessment. Visual inspection of the River Lee at Morrison's Island was conducted across the riverbed and attendant bankside/ quayside areas associated with the proposed Flood Alleviation Works (Figure 8). Inspection included field-walking of the river's intertidal area and underwater survey of its subtidal channel.

On-site assessment comprised the systematic visual inspection of the in-water extent of the proposed works. The archaeological assessment sought to record riverbed and bankside/ quayside topography, assess the potential of riverbed deposits to retain archaeological material, and identify any features/structures of archaeological or historic significance that are present. In addition, targeted metal-detection was employed to help assess the riverbed and highlight any metallic concentrations present within those deposits.

A Leica Total Station EDM and Topcon DGPS unit facilitated the gathering of survey data and the position-fixing any features encountered. In addition, a series of scaled isometric/perspective drawings, detailing various aspects of the existing quayside environment at Morrison's Island were also produced (Figures 9-12). A Fisher *Aquanaut* 1280U and Tesoro *Compardre* metal detectors were used for the Magnetometer survey. However, reliable metal-detection survey was not feasible due to the level of in-water metallic debris present.

The survey team comprised of underwater archaeologists, a diving engineer, and a certified surveyor. The dive operations were carried out to HSA/HSE standard using surface supplied equipment, supported with suitable boat cover (licensed workboat and Skipper supplied by Cork Harbour Boats) and mobile/ VHF communications to the Port Operations Centre, in accordance with the Safety in Industry (Diving Operations) Regulations 1981, SI 422.

4.1 Terminology

When referring to the degree of compaction observed for the riverbed deposits under inspection, the terms loose, medium, and hard are relative and do not relate to the measured properties of these deposits. When referring to sediment grain size, the Wentworth scale was adopted, as detailed in Table 1.

Size (mm)	Grade
>256	Boulder
>64	Cobble
>4	Pebble
>2	Granule (gravel)
>1	Very coarse sand
>1/2	Coarse sand
>1/4	Medium sand
>1/8	Fine sand
>1/16	Very fine sand
>1/32	Coarse silt
>1/64	Medium silt
>1/128	Fine silt
>1/256	Very fine silt
<1/256	Clay

Table 1: Sediment grain size categories as applied to riverbed deposits discussed in the report.

5.0 ARCHAEOLOGICAL ASSESSMENT

5.1 River Topography

An underwater survey of the sub-tidal channel of the South Channel between Parliament Bridge and Parnell Bridge was undertaken, using Surface Supplied Diving Equipment to HSE/HSA standards. No archaeologically or historically significant material, structures, or deposits were encountered as part of this endeavour. A summary description of the riverbed deposits observed as part of the underwater survey is provided below.

The riverbed located between Parliament Bridge and Parnell Bridge is of medium compaction and predominantly composed of small pebbles (<40mm) with frequent cobbles (<70mm) also present; only occasional boulders, measuring up to 300mm in length x 200mm in width being noted (Plate 2). The aforementioned deposits overlie a sub-stratum of gravel (<2mm) and coarse sand. This sub-stratum is frequently exposed and a hand-penetation depth of 300mm can be achieved for these areas (Plate 3). In general, the riverbed retains its natural character and has a good holding-content, particularly for those riverbed areas adjacent to George's Quay and the upstream side of Union Quay.

Sediment deposition was noted along the north side of the channel. This was particularly evident adjacent to Morrison's Quay, downstream of Trinity Footbridge (Plate 4). Deposition comprises coarse sand (<1mm) and gravel (<3mm), with frequent pebble (<30mm) and cobble (<70mm) inclusions. Occasional angular boulders (<350mm) are also present. It would appear that the topography of Morrison's Island is functioning much like a natural river meander. As a result, river-flow

predominantly affects the central and southern sides the river channel, as it flows past Union Quay. In contrast, flow-velocity is decreased along the base of the opposing Morrison's Quay; providing conditions suitable for the deposition of waterborne sediments.

5.2 Visual Survey and Assessment

A total of five features of historic significance have been identified for the area under assessment. These include: two masonry quays (**F001-F002**), including their associated timber fenders and river-access steps a masonry culvert (**F002a**), and two bridge structures (**F003-F004**) that define the upstream and downstream limits of Morrison's Island. The above features were also included as part of the UAIA for the Lower Lee (Cork City) Drainage Scheme; Features F042, F043, F043a, F003, and F008 respectively.

F001/F002, Father Matthew Quay (formerly Charlotte Quay) and Morrison's Quay: these quays from one continuous structure of early nineteenth-century date that delineates the north side of the channel, surrounding Morrison's Island (Plate 5). A modern footbridge, Trinity Footbridge, spans the river at the apex of Morrison's Island, where Fatter Matthew and Morrison's Quay conjoin (Plates 6-7). This pedestrian bridge was built in 1977 and comprises a poured mass-concrete structure, supported on two in-water piers with steel railings forming the superstructure.

The conjoined quays measure 520m in length and are constructed of neatly-cut, string-coursed, limestone masonry; a total of ten-courses being visible at Low Water. The masonry is fairly regular in size and shape, measuring between 700mm in length x 450mm in with and 1m in length x 450mm in width (Plates 8-9). The entire structure has been subject to consolidation work along it foundations. Two types of consolidation works are present. The first comprising a series of close-set vertical timber piles (300mm x 300mm) that are offset c.200mm from the base of the quay wall, behind which concrete has been poured (Plates 10-11). This underpinning of the quay is identical in type to that observed for the opposing George's Quay/Union Quay. The second type comprises vertical timbers that are set flush to the quay wall, extending to a height of c.1.4m and spaced 200mm-300m apart; the spaces between these timbers having been in-filled with a rough-mix concrete (Figure 9, Plate 12).

A series of greenheart timber fenders, numbering 100m in total, have been placed at regular intervals along approximately 90% the quayside structure; the fenders only being absent from a small c. 50m section of Father Matthew Quay (Plates 13-17). The fenders form composite structures, constructed using two lengths of greenheart timber and a series of associated wrought-iron fixings/fastenings (Figures 10 and 11B). The inner timber is vertically set against the quay wall and measures 300mm in width x 160mm in depth; extending the full height of the quay wall (c. 3m). It is fastened to the wall at a point c. 2m from its base, using a wrought-iron bar strap that loops round the timber. In turn, the strap is fixed to the quay wall by a set of iron pins (square-headed; 40mm x40mm) that measure 20mm in diameter. The outer, bracing, timber is raked at a 70° angle, rising from a point c.500mm

from the base of the quay wall. This timber measures 300mm x 300mm and is also fastened to the wall using a wrought-iron bar strap. The strap surrounds both timbers and is fixed to the quay wall at a point c. 1.5 from its base. In addition, a wrought-iron clenching-rod (20mm diameter) has been driven into the timber sides to pull the abutting timbers together, positioned at a point c. 40mm from the top of each timber. An iron-cap encases both timber heads, held in place by a wrought-iron bar strap that extends from the top of the quay. This strap runs across the top of each timber and down the outer face of the outer bracing timber; fastened to the quay wall and the bracing timber using four iron pins (20mm diameter) (Plates 16-17). It was also noted that fenders found along Morrison's Island conform in design/fabric to that observed elsewhere along the South Channel quays.

A flight of masonry river-access steps are located approximately mid-point along Father Matthew Quay and two others are located on Morrison's Quay; placed mid-point along the quay and at its downstream terminus (Figure 12, Plates 18-19). These river-access points are all of similar design, each flight comprising eighteen masonry steps with a larger landing-step located mid-way (High Water Mark) down the structure. The bottom steps all terminate a short distance above the Low Water Mark. In addition, two river-access ladders (wrought-iron) are also located along Father Matthew Quay. The first is located at NGR: 167542E, 715649N and comprises a ladder that has been retro-fitted to the quay wall (see Figure 11A). The second, located at NGR: 167594E, 715397N, is integral to the quay structure, being recessed into the quay wall (see Figure 9A). A total of seven wrought-iron bars span the recess to form the ladder rungs.

A series of rectangular drain features, forty-two in total, are present along the structures extent, located along the base of quay wall (below the High Water Mark). Fourteen of these drains are rectangular in shape, measuring up 400mm height x 160mm height (Plate 20). The remaining twenty-eight drain features are larger, measuring 600m in height x 400m in width (Plate 21). An arched-culvert (**F002a**) is located c.68m along Morrison's Quay, NGR: 167844E, 71717N (Plate 22). The arch-ring is segmental in form and comprises seven visible arch-stones. This structure has been subject to modern repair using concrete blockwork and cement render.

Ten wrought-iron mooring hoops are visible along the face of the quay walls. Five of these comprise moorings (250mm internal diameter) associated with the aforementioned river-access steps, placed to accommodate small craft using these access points (Plate 23). The other four comprise more substantial moorings (400mm-500mm internal diameter), designed to accommodate the larger sailing vessels that once moored along Morrison's Island. One of these is located at the southern terminus of Farther Mathew Quay, the other three being located along Morrison's Quay (Plate 24). In addition, a cast iron mooring-bollard is located at the southern end of Morrison's Quay at NGR: 167848E, 717223N (Plate 25). Similar moorings are found on the Lapp's Quay, downstream of Parnell Bridge (Plate 26). However these are of a slightly different shape and are embossed with their makers mark: '*R. Perrott & Sons, Cork, 1887*'. Many of the mooring bollards that adorn the city's quays were

produced by the Hive Foundry, once located on Hanover Street, an enterprise which was responsible of much of the nineteenth-century ironwork to be found throughout the city.

F003, Parliament Bridge: the original Parliament Bridge, built sometime in the 1760s, was the next bridge to be built within the city (as depicted on Roques 1773 map). It was located on the South Channel and provided access between Sullivan's Quay and Charlotte Quay (now Father Matthew Quay). The bridge was replaced in 1806, following flood damage sustained in 1804. The replacement bridge still stands today and forms an elegant, single-arched, bridge composed of neat-cut limestone masonry, with cut-stone balustrade, fine *voussoirs*, and *modillion* cornices (Plate 27). Timber shuttering is evident on the in-river sides of the bridge's north pier (Plate 28). This comprises close-set vertical timbers with horizontal shutters, behind which the pier's foundations have been laid (comprising bonded rubble-stone and mortar). A laid-stone apron, which originally covered these foundations, remains partially intact; its southernmost extent having become eroded. A series of substantial timber piles protrude from the foundations and are likely to be associated with the previous eighteenth-century bridge at this location. Parliament Bridge measures 29m in length x 13m in width. The bridge was refurbished in the 1990s and some of the masonry was replaced using concrete in 1922.

F004, Parnell Bridge: stands on the site of two former bridge structures, named Anglesea Bridge. The original structure was built on the South Channel in 1830 to provide access from Anglesea Road/Corn Exchange to the south and Warren Place to the north (Plates 29-30). An extract from Lewis Topographic Dictionary provides a description of the bridge, shortly after it was completed:

Anglesey bridge, erected in 1830 by Sir Thomas Deane, from a design by Mr. Griffiths, is a very handsome structure of hewn limestone, with parapets of cast iron; and consists of two elliptic arches 44 feet in span, with a rise of eleven feet, having between them a waterway of 32 feet crossed by two parallel drawbridges of cast iron, which are raised to admit vessels above it.⁴

By the late 1800s, increased traffic levels on the bridge required its replacement, its foundations having become unsafe. Anglesea Bridge was replaced, in 1882, by a steel lattice girder structure of swing-bridge design (Plate 31). The swing bridge, renamed Parnell Bridge, was designed by T. Claxon Fiddler (London) to allow greater shipping access to the South Channel; the bridge comprising a swinging central-span with two fixed ends (Plate 32). A journal extract from 1884 provides a detailed description of the newly built bridge shortly after its construction:

two abutments and two intermediate piers, each consisting of a pair of cast-iron cylinders or columns, as shown by the dotted circles upon the general plan. The central opening is that which serves for the passage of vessels. The swing bridge extends over two openings, from the north abutment to the southern pier, its centre of revolution being situated over the centre of the northern span, and revolves upon a turntable, which is carried upon a lower platform or frame of girders extending across the northern span of the bridge. The southern opening is spanned by an ordinary pair of lattice girders in line with the girders and superstructure of the swing bridge.⁵

⁴ Samuel Lewis, A Topographical Dictionary of Ireland, 1837.

⁵ Scientific American Supplement, No. 446, 1884, www.archiseek.com.

The remains of this phase of bridge construction are evident below the modern Parnell Bridge. A semi-circular section of bridge abutment, composed of neat-cut limestone masonry, is located on the south side of the bridge (Plate 33); an extended abutment once formed the pivot-point of the swing-bridge. A set of masonry steps are inset into the southern quayside, on the upstream side of the bridge and immediately downstream of Union Quay (Plate 34). These steps formed part of the original Parnell Bridge, providing access to the river and the southern bridge abutment. Bridge remains are also evident on the north side of the channel with nine courses of neat-cut limestone (measuring a uniform 1m in length x 0.50m in width) forming the northern bridge abutment (Plate 35). The swing bridge was removed and replaced by the existing three-span Parnell Bridge in 1971, a pre-cast mass concrete structure supported by two in-water piers (Plate 36). The current Parnell Bridge measures 47m in length x 25.6m in width.

5.3 Conclusion

The two quays that form Morrison's Island are part of a series of historic quay structures that define both the north and south channels of the River Lee. A total of twenty-three quays are located within Cork City, eleven located along the North Channel and twelve along the South Channel. These quays form an integral part of a maritime-based city such as Cork. However, not all of Cork's quays are listed in the NIAH or have existing protected status; this absence from the inventory applying to both Morrison's Quay and Father Matthew Quay. Therefore, the present assessment adds further sites to the record, adding to the baseline data sets being sought. Parliament Bridge and Parnell Bridge were included in the assessment, as these structures lie a short distance to the east and west of the proposed flood alleviation works. However, it is not anticipated that these structures will be impacted by the proposed development.

6.0 PROPOSED IMPACTS⁶

The impact categories used have regard to those set out in the 'Guidelines on the information to be contained in Environmental Impact Statements', 2002, EPA, 'Advice notes on Current Practice (in preparation of Environmental Impact Statements)', 2003, EPA, and Guidelines for the Assessment of Archaeological Heritage Impacts of National Road Schemes, National Roads Authority.

In-river works associated with proposed works are minimal, much of the proposed flood defence work being undertaken at street level or set back from the river channel in the form of flood defence walls/embankments. In addition, no dredging of the waterway is proposed as part of the flood alleviation works at Morrison's Island. The proposed impacts and mitigation proposals for the features identified as part of the UAIA are tabulated in Table 2.

⁶ This section does not purport to relate to precise engineering details but is rather an attempt to understand the nature of the impact on the potential archaeological environment, based on the supplied data.

The level of impact and proposed mitigation for the street-level interventions associated with the flood alleviation works at Morrison Island has been undertaken separately by John Cronin and Associates. Proposed interventions to the lower components of the quay structure constitute, in the main part, localised maintenance and repair of the quay-façade and the insertion of micro-piles along their foundations. This intervention work does not have a significant impact on the existing structures, and can be considered to have a slight positive impact. There are no direct in-river impacts associated with the proposed works.

7.0 MITIGATION

Archaeological monitoring is required for all of the proposed direct defence interventions located along the quayside areas that comprise Morrison's Island. This will allow the works to be suitably monitored and any additional recoding of each structure to be undertaken. It is understood that the timber piles/fenders that line Father Matthew Quay and Morrison's Quay will not be impacted by the proposed development and are to remain *in-situ*. It is also understood the river-access ladders (two in number) and river-access steps (three in number) are remain unaffected by the proposed development. It is anticipated that a cast-iron mooring bollard and a number of sections of cast-iron railings, currently adorn the quayside area, will be subject to removal.⁷ However, it is also noted that these are to be sympathetically incorporated back into the streetscape/ quayside on completion of the proposed works.

Feature Number	Feature Name/ Type	Proposed works	Potential Impacts	Archaeological Mitigation
F001 [F042 in EIS]	Father Matthey Quay	The existing river wall and foundation zones are to be grouted. The granular soil backing zone is to be grouted. The face of the existing wall is to be cleaned and repointed and the stonework repaired where necessary. Existing railings to be removed and reinstated.	The maintenance and repair of the existing quay wall will result in a Slight Positive Impact.	No further in-water mitigation required. Any ground excavation works adjacent to the quayside to be archaeologically monitored.
F002 [F043 in EIS]	Morrison's Quay	The existing river wall and foundation zones are to be grouted. The granular soil backing zone is to be grouted. The face of the existing wall is to be cleaned and repointed and the stonework repaired where necessary. Existing railings to be removed and reinstated.	The maintenance and repair of the existing quay wall will result in a Slight Positive Impact.	No further in-water mitigation required. Any ground excavation works adjacent to the quayside to be archaeologically monitored.
F002a [F043a in EIS]	Culvert; Morrison's Quay	----	No Impact	No further mitigation required
F003 [F003 in EIS]	Parliament Bridge		No Impact	No further mitigation required

⁷ Note: specific mitigation is provided for these components as part of the Archaeological and Architectural Heritage Impact Assessment for the proposed works.

Feature Number	Feature Name/ Type	Proposed works	Potential Impacts	Archaeological Mitigation
F004 [F008 in EIS]	Parnell Bridge [site of Anglesea Bridges]	----	No Impact	No further mitigation required

Table 2: Proposed impacts and mitigation for historic features identified as part of the UAIA at Morrison's Island.

8.0 RECOMMENDATIONS

8.1 Pre-construction Measures

No further ameliorative measures are recommended in advance of the flood alleviation works commencing at Morrison's Island.

8.2 Construction Phase Measures

ARCHAEOLOGICAL MONITORING. Archaeological monitoring in accordance with the terms of Section 5 of the National Monuments Act (2004 Amendment) is recommended during riverbed and bankside/quayside disturbances associated with the proposed flood alleviation works. These measures will ensure that any sub-surface remains of archaeological or historic value are dealt with in an appropriate archaeological manner.

RETAINING AN ARCHAEOLOGIST/S. An archaeologist should be retained for the duration of the relevant works. The archaeologist should be familiar with and experienced in river/estuarine environments.

THE TIME SCALE for the construction phase should be made available to the archaeologist, with information on where and when ground disturbances and dredging will take place.

SUFFICIENT NOTICE. It is essential for the developer to give sufficient notice to the archaeologist/s in advance of the construction works commencing. This will allow for prompt arrival on site to monitor the ground disturbances. As often happens, intervals may occur during the construction phase. In this case, it is also necessary to inform the archaeologist/s as to when ground disturbance works will recommence.

DISCOVERY OF ARCHAEOLOGICAL MATERIAL. In the event of archaeological features or material being uncovered during the construction phase, it is crucial that any machine work cease in the immediate area to allow the archaeologist/s to inspect any such material.

ARCHAEOLOGICAL MATERIAL. Once the presence of archaeologically significant material is established, full archaeological recording of such material is recommended. If it is not possible for the construction works to avoid the material, full excavation would be recommended. The extent and

duration of excavation would be a matter for discussion between the client and the statutory authorities.

ARCHAEOLOGICAL TEAM. It is recommended that the core of a suitable archaeological team be on standby to deal with any such rescue excavation. This would be complimented in the event of a full excavation.

SECURE SITE OFFICES and facilities should be provided on or near those sites where excavation is required.

FENCING of any such areas would be necessary once discovered and during excavation.

ADEQUATE FUNDS to cover excavation, post-excavation analysis, and any testing or conservation work required should be made available.

MACHINERY TRAFFIC during construction must be restricted as to avoid any of the selected sites and their environs.

SPOIL should not be dumped on any of the selected sites or their environs.

PLEASE NOTE: All of the above recommendations are based on the information supplied for the Morrison's Island Flood Alleviation Works, as part of the Lower Lee (Cork City) Drainage Scheme. Should any alteration occur, further assessment maybe required.

PLEASE NOTE: Recommendations are subject to the approval of The Department of Culture Heritage, and the Gaeltacht.

9.0 ACKNOWLEDGEMENTS

Thanks are extended to Johnathan Reid, Senior Project Engineer at Ryan Hanley, consulting engineers for the proposed scheme. Thanks are also extended to Tony Cummins, Archaeologist at John Cronin and Associates. The Survey Team comprised Rex Bangerter (Project Maritime Archaeologist), Daniel Lenehan (Archaeologist), Feargal Morrissey (Engineer Diver), MacDara Lynch (Commercial Diver), Brian McAllister (Dive Supervisor) and Derek Copeland (Surveyor). The report was written by Bangerter and edited by Dr Niall Brady.

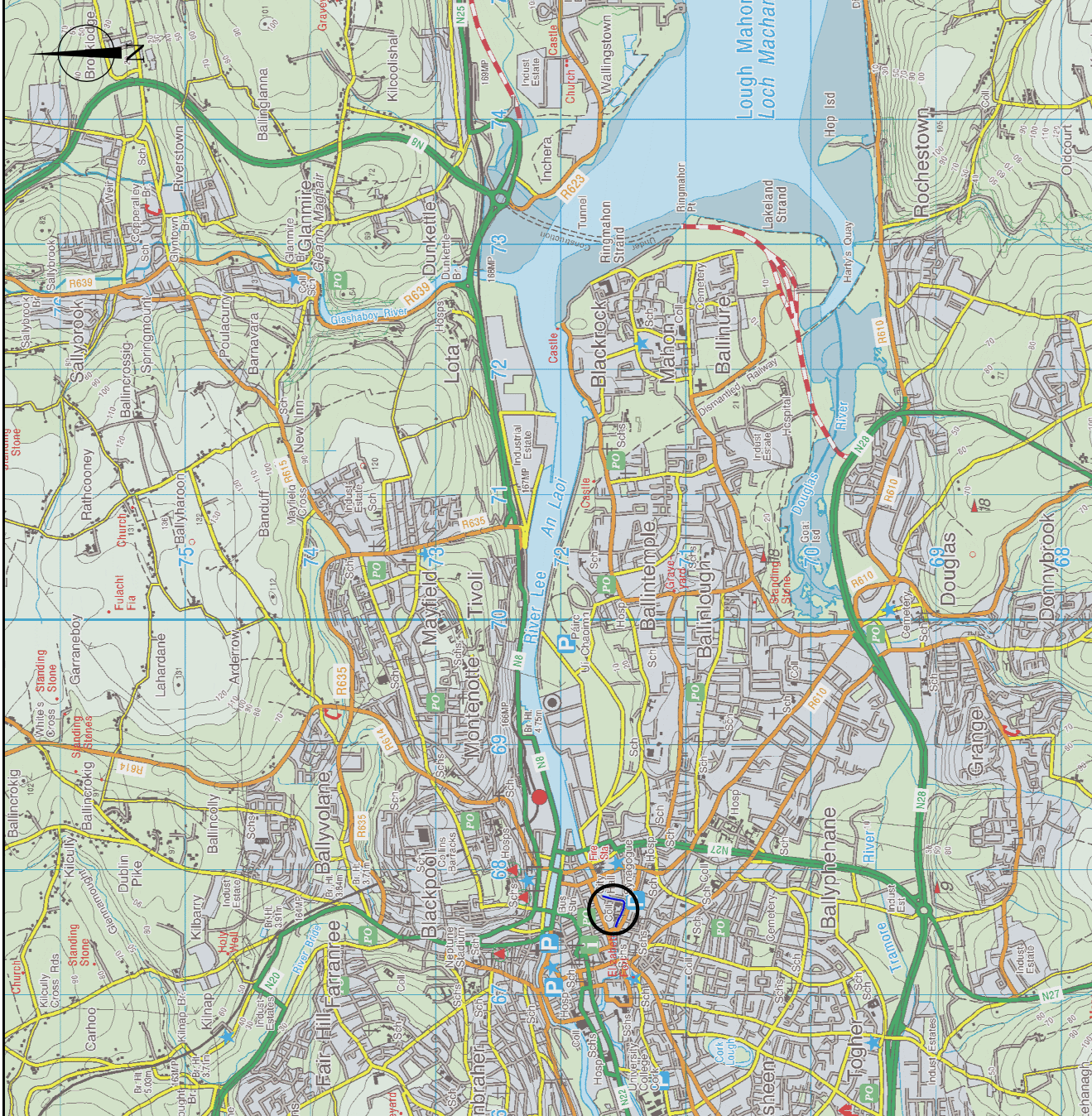
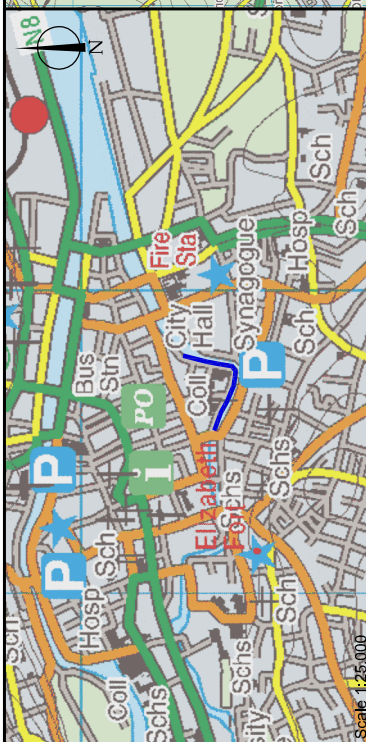

Notes source: OSI Discovery Series Mapping Extent of Survey Area at Morrison's Island	A4 Job/Exc No. Morrison's Island Date 10.11.17	Compiled by R. Bangerter Scale 1:50,000/1:25,000	CAD reference LowerLeeFRS Drawing No. Figure 1	Client Ryan Hanley Consulting Engineers Project UAMA, Morrison's Island Flood Alleviation Works	Title Figure 1- Extract from OS Map showing location and extent of ADCO Survey Area along the River Lee at Morrison's Island, Cork City.
--	---	---	---	--	--





① - Dunbar's Marsh later reclaimed to form Morrison's Island.

Figure 3 (1773 map of Cork City)
 Figure 4 (1801 map of Cork City)
 Figure 5 (1832 map of Cork City)

Title
 Figure 2- Extract from John Rocque's Map of 1759,
 A Survey of the City and Suburbs of Cork.

Source: Cork City Archives [www.corkpastandpresent.ie/maps]

ADCO

Client
 Ryan Hanley Consulting Engineers

Project	Job/Exc No.	Compiled by	CAD reference
UAIA, Morrison's Island Flood Alleviation Works	16D0053	R.Bangerter	Morrison's_Island

A4	Date	Scale	Drawing No.
	10.11.17	1:10,000	Figure 2



- 2 - Area reclaimed (later forming Morrison's Island).
- 3 - Parliament Bridge (later extended).
- 4 - Continued development on south side of channel.
- 5 - Tuckey's Quay reclaimed up to Daunt's Bridge.

Notes Figure 2 (1759 map of Cork City) Figure 4 (1801 map of Cork City) Figure 5 (1832 map of Cork City)		A4 Job/Exc No. 18D0053 Date 10.11.17	Compiled by R.Bangerter Scale 1:10,000	CAD reference Morrison's Island Drawing No. Figure 3	Client Ryan Hanley Consulting Engineers Project UAIA, Morrison's Island Flood Alleviation Works	Title Figure 3- John Rocque's Map of 1773, A Survey of the City and Suburbs of Cork. Source: Cork City Archives [www.corkstandpresent.ie]
--	--	---	---	---	--	---





6 Charlotte Quay, Lawton's Quay, and Morrison's Quay now forming 'Morrison's Island'.
 7 Dunscomb's Marsh realigned to form Lapp's Island, adjacent to Cold Harbour Quay.
 8 Upstream terminus of the New Wall (later known as the Navigation Wall).

A4	Job/Exc No. 16D0053	Compiled by R. Bangerter	CAD reference Morrison's Island	Client Ryan Hanley Consulting Engineers	Title Figure 4- Extract from a Plan of the City and Suburbs of Cork, according to the latest Improvements, by William Beauford, 1801. Source: Cork City Archives [www.corkpastandpresent.ie]
	Date 10.11.17	Scale 1:10,000	Drawing No. Figure 4	Project UAIA, Morrison's Island Flood Alleviation Works	

Notes
 Figure 2 (1759 map of Cork City)
 Figure 3 (1773 map of Cork City)
 Figure 5 (1832 map of Cork City)





- 9 Great George's Street newly constructed [now renamed Washington Street].
- 10 Site of Newham's Quay [reclaimed to form Corn Market Street].
- 11 Site of original Lavitt's Quay [reclaimed to form Nelson Place, later becoming Emmett Place].
- 12 Site of Cold Harbour Quay [reclaimed to form Warren's Place, later Custom House Street].
- 13 Lawton's Quay forming north side of Morrison's Island reclaimed to form South Mall Road.
- 14 Reclamation of Allen's Mash to form Union Island and the Corn Market.
- 15 Anglesea Bridge [built 1830, replaced 1882, and later Parnell Bridge built in 1971].
- 16 Reclamation of land to facilitate a Custom's House at downstream confluence of the River Lee.

Notes Figure 2 (1759 map of Cork City) Figure 3 (1773 map of Cork City) Figure 4 (1801 map of Cork City)	A4 Job/Exc No. 16D0053 Date 11.11.16	Compiled by R. Bangertner Scale 1:10,000	CAD reference Morrison's Island Drawing No. Figure 5	Client Ryan Hanley Consulting Engineers Project UAlA, Morrison's Island Flood Alleviation Works	Title Figure 5- Extract from a Plan of the City and Suburbs of Cork, surveyed and drawn by Thomas Holt, 1832. Source: Cork City Archives [www.corkstandpresent.ie]
--	---	---	--	--	---



572341

ITM CENTRE PT. COORDS

567378,571911

DESCRIPTION

MAP SHEETS

6 inchBE1
CK074

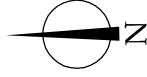

Arna thimle agus ara thimle ag Surbhéacht Ordánais Éireann, 2016 an Fhionúisce, Ball Áis Clárú & Éire. Complete and published by Ordnance Survey Ireland, Phoenix Park, Dublin 8, Ireland.

Siarnámh agus ara thimle ag Surbhéacht Ordánais Éireann agus Rialas na hÉireann. Unauthorised reproduction infringes Ordnance Survey Ireland and Government of Ireland copyright.

Each copy of a map is the property of Ordnance Survey Ireland. It is loaned to you on the understanding that you will not copy, reproduce or transmit it in any form or by any means without the prior written permission of the copyright owners.

NI thimleann tuairisc ar aon ábhar a bhfuil sé ar fáil ag Surbhéacht Ordánais Éireann. Ní ceadar aon ábhar a chloic, a chur ar ais nó a athscráil a dhéanamh ná a chur ar fáil arís gan cead. Ní ceadar aon ábhar a chloic, a chur ar ais nó a athscráil a dhéanamh ná a chur ar fáil arís gan cead. Ní ceadar aon ábhar a chloic, a chur ar ais nó a athscráil a dhéanamh ná a chur ar fáil arís gan cead.

NI thimleann tuairisc ar aon ábhar a bhfuil sé ar fáil ag Surbhéacht Ordánais Éireann agus Rialas na hÉireann. Ní ceadar aon ábhar a chloic, a chur ar ais nó a athscráil a dhéanamh ná a chur ar fáil arís gan cead. Ní ceadar aon ábhar a chloic, a chur ar ais nó a athscráil a dhéanamh ná a chur ar fáil arís gan cead.

Ordnance Survey maps never show legal property boundaries nor do they show ownership of physical features.

© Surbhéacht Ordánais Éireann, 2016
© Ordnance Survey Ireland, 2016

571481



Notes
Source: OSI Historic Map Archive
Ⓜ Map item corresponding to cartographic observations discussed in the UAlA report.

A4
Job/Exc No. 16D0053
Date 10.11.17

Compiled by
R. Bangster
Scale
1:5000

CAD reference
Morrison's Island
Drawing No.
Figure 6

Client
Ryan Hanley Consulting Engineers
Project
UAlA, Morrison's Island Flood Alleviation Works

Title
Figure 6- Extract from OS First Edition (1841)
Map showing Morrison's Island with approximate location of proposed Flood Alleviation Works superimposed.

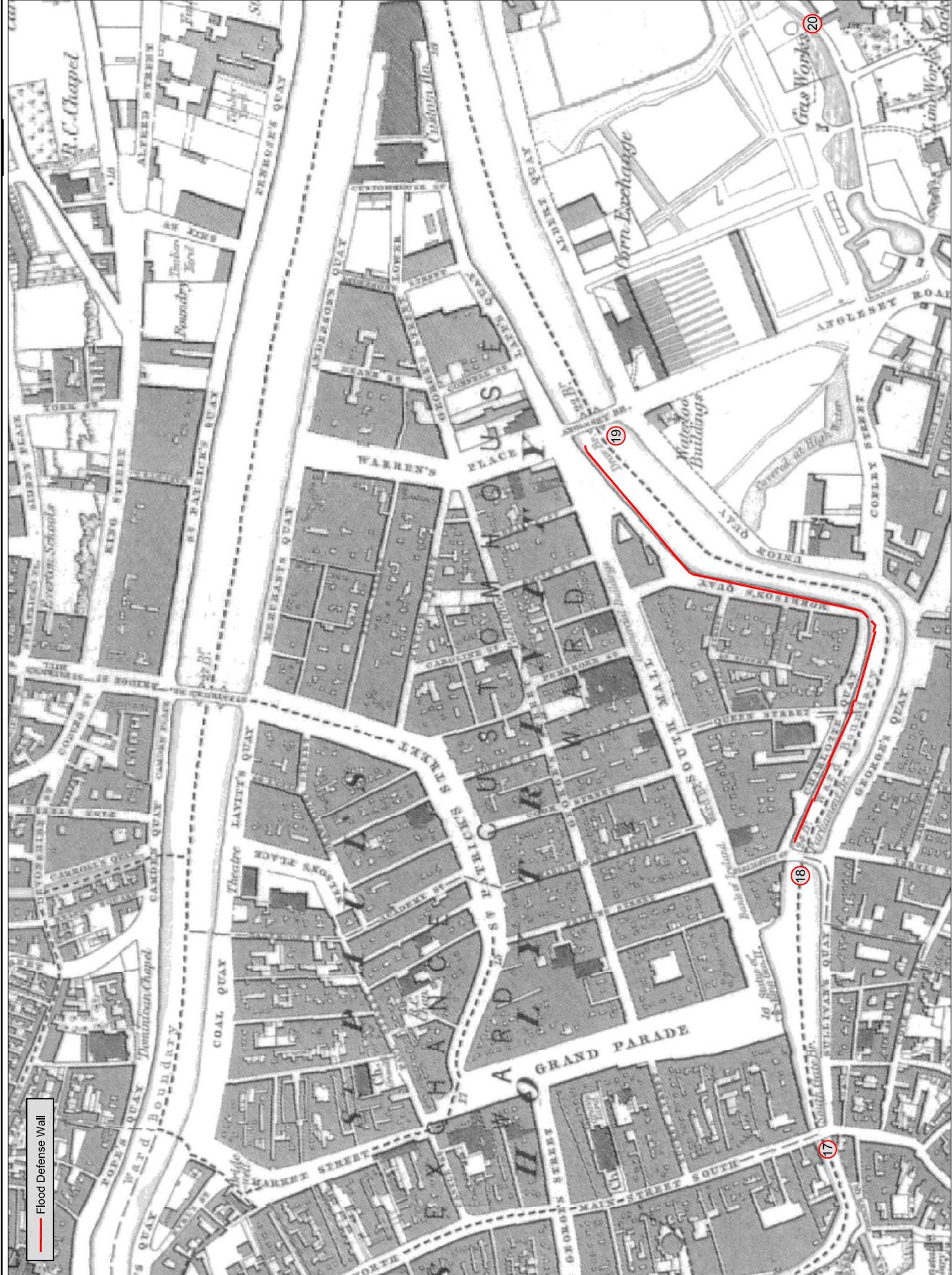

Flood Defense Wall

ITM CENTRE PT. COORDS

567678,571911

DESCRIPTION

MAP SHEETS

25 inch BE1
CK074-06 CK074-07
CK074-10 CK074-11

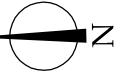

Áiríú áiríú agus íosláib ag Súrthéacht Ordánais Éireann, Peirc an Fhionúlaca, Baile Átha Cliath 8, Éire.
Compiled and published by Ordnance Survey Ireland, Phoenix Park, Dublin 8, Ireland.

Sainmhíneadh réamhshuíochán a bhfuil áiríú áiríú agus íosláib ag Súrthéacht Ordánais Éireann agus íosláib ag Súrthéacht Ordánais Éireann, Peirc an Fhionúlaca, Baile Átha Cliath 8, Éire.
Unauthorised reproduction of Ordnance Survey Ireland and Government of Ireland copyright.

Gach cead a ceadaim. Ní ceadaim ach a chuid aon áiríú áiríú agus íosláib a bhfuil áiríú áiríú agus íosláib ag Súrthéacht Ordánais Éireann agus íosláib ag Súrthéacht Ordánais Éireann, Peirc an Fhionúlaca, Baile Átha Cliath 8, Éire.
All rights reserved. No part of this publication may be copied, reproduced or transmitted in any form or by any means without the prior written permission of the copyright owners.

Ní hionann dothar, dothéach nó cead aon áiríú áiríú agus íosláib ag Súrthéacht Ordánais Éireann agus íosláib ag Súrthéacht Ordánais Éireann, Peirc an Fhionúlaca, Baile Átha Cliath 8, Éire.
The representation on this map of a feature or topography is not evidence of the existence of a right of way.

Ní hionann leagan léarsaí de chuid Ordánais Súrthéacht ra íosláib leagan phointe dea-thuairisc leagan léarsaí, ná áiríú áiríú agus íosláib ag Súrthéacht Ordánais Éireann agus íosláib ag Súrthéacht Ordánais Éireann, Peirc an Fhionúlaca, Baile Átha Cliath 8, Éire.
Ordnance Survey maps never show legal property boundaries nor do they show ownership of physical features.

© Súrthéacht Ordánais Éireann, 2016
© Ordnance Survey Ireland, 2016

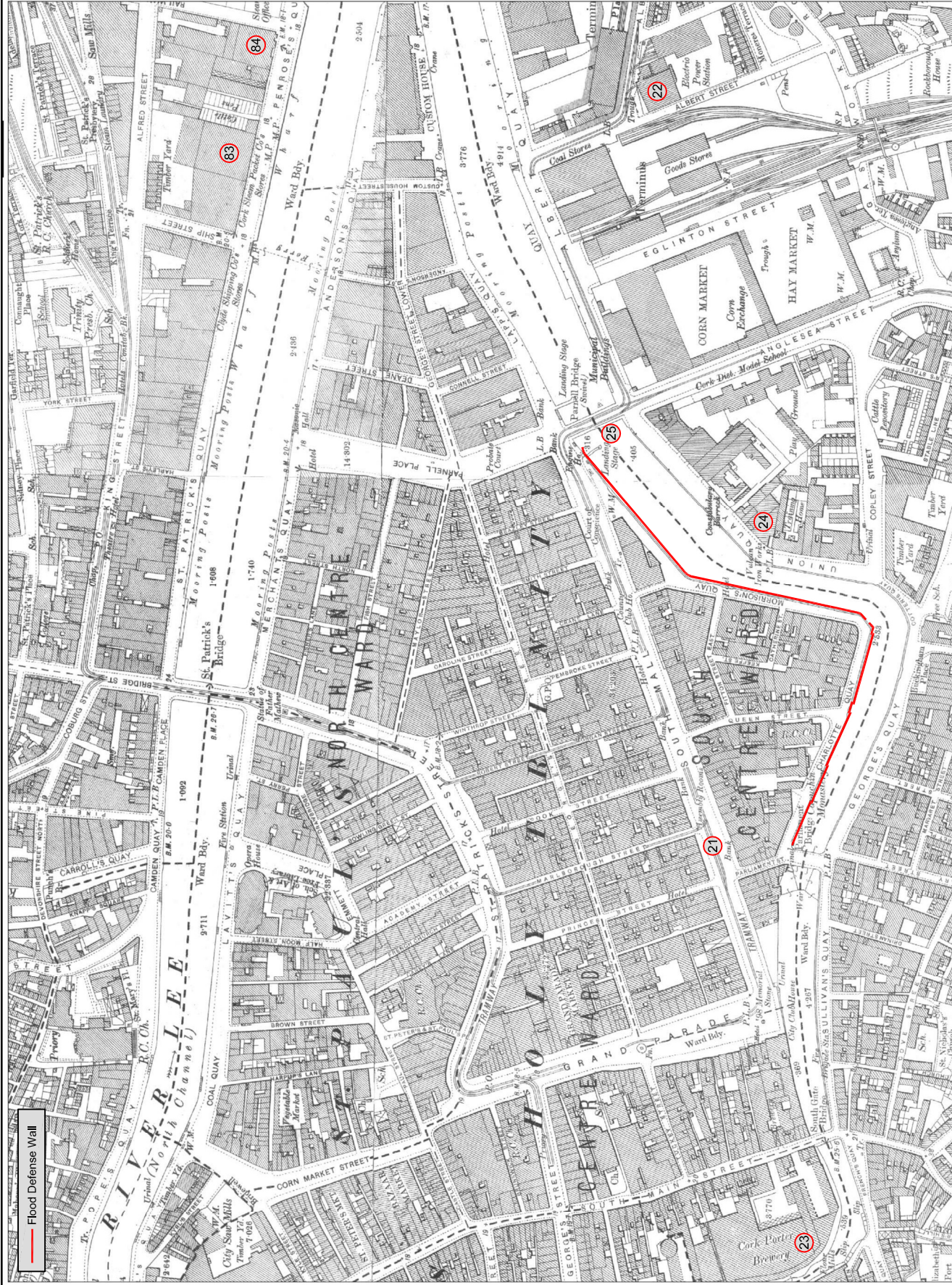

<p>Title Figure 7- Extract from OS 25-inch (1899) Map showing Morrison's Island with approximate location of the proposed Flood Alleviation Works superimposed.</p>	
<p>Client Ryan Hanley Consulting Engineers</p>	<p>Project UAlia, Morrison's Island Flood Alleviation Works</p>
<p>CAD reference Morrison's Island</p>	<p>Drawing No. Figure 7</p>
<p>Compiled by R. Bangert</p>	<p>Scale 1:5000</p>
<p>Job/Exc No. 16D0053</p>	<p>Date 10.11.16</p>
<p>A4</p>	<p>Notes Source: OSI Historic Map Archive Ⓢ Map item corresponding to cartographic observations discussed in the UAlia report.</p>





Scale 1:5000

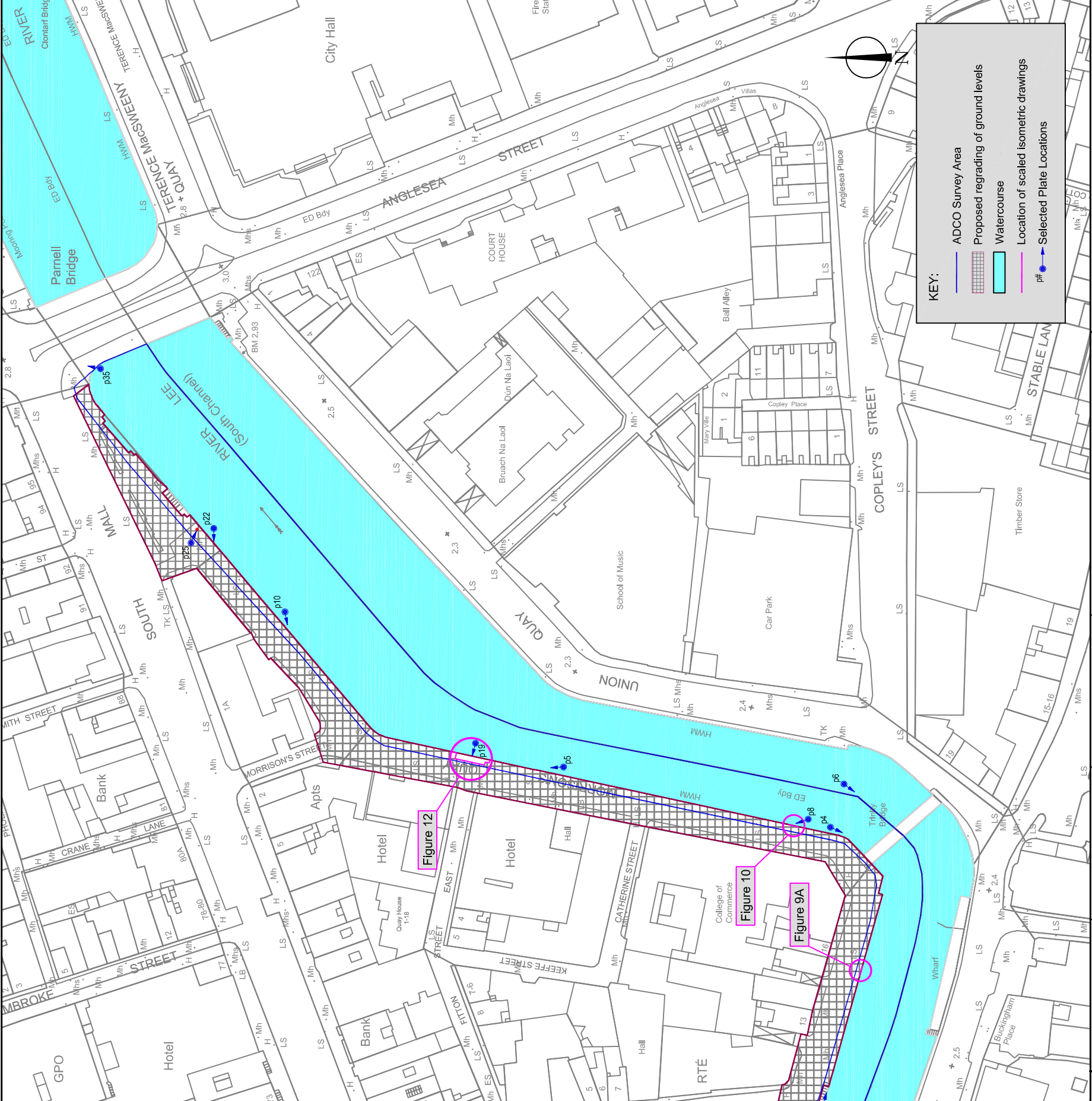

<p>Notes</p> <ul style="list-style-type: none"> - Survey data superimposed on OS Background Mapping. - Survey extent NGR: 167529E, 715541N (upstream) to NGR: 167910E, 717393N (downstream). - Extent of regrading provided for illustrative purposes only. 		<p>Job/Exc No. 16D0053</p> <p>Date 10.11.17</p>		<p>Compiled by R.Bangerter</p> <p>Scale 1:2000/ 1:5000</p>		<p>CAD reference Morrison's_Island</p> <p>Drawing No. Figure 8</p>		<p>Client Ryan Hanley Consulting Engineers</p> <p>Project Morrison's Island Flood Alleviation Works</p>		<p>Title Figure 8- Location and extent of ADCO Survey Area at Morrison's Island, South Channel of the River Lee, with selected plate locations superimposed. [Thumbnail: Aerial Image of Morrison's Island Survey Area].</p>	
---	--	---	--	--	--	--	--	---	--	---	--



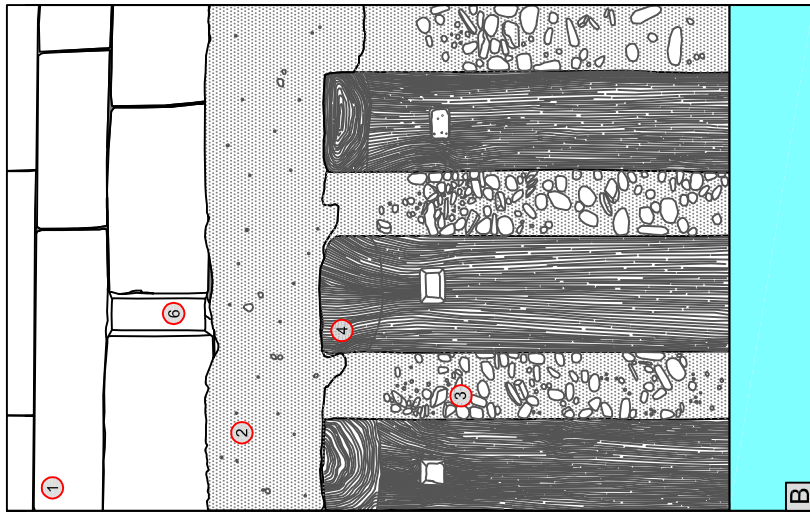
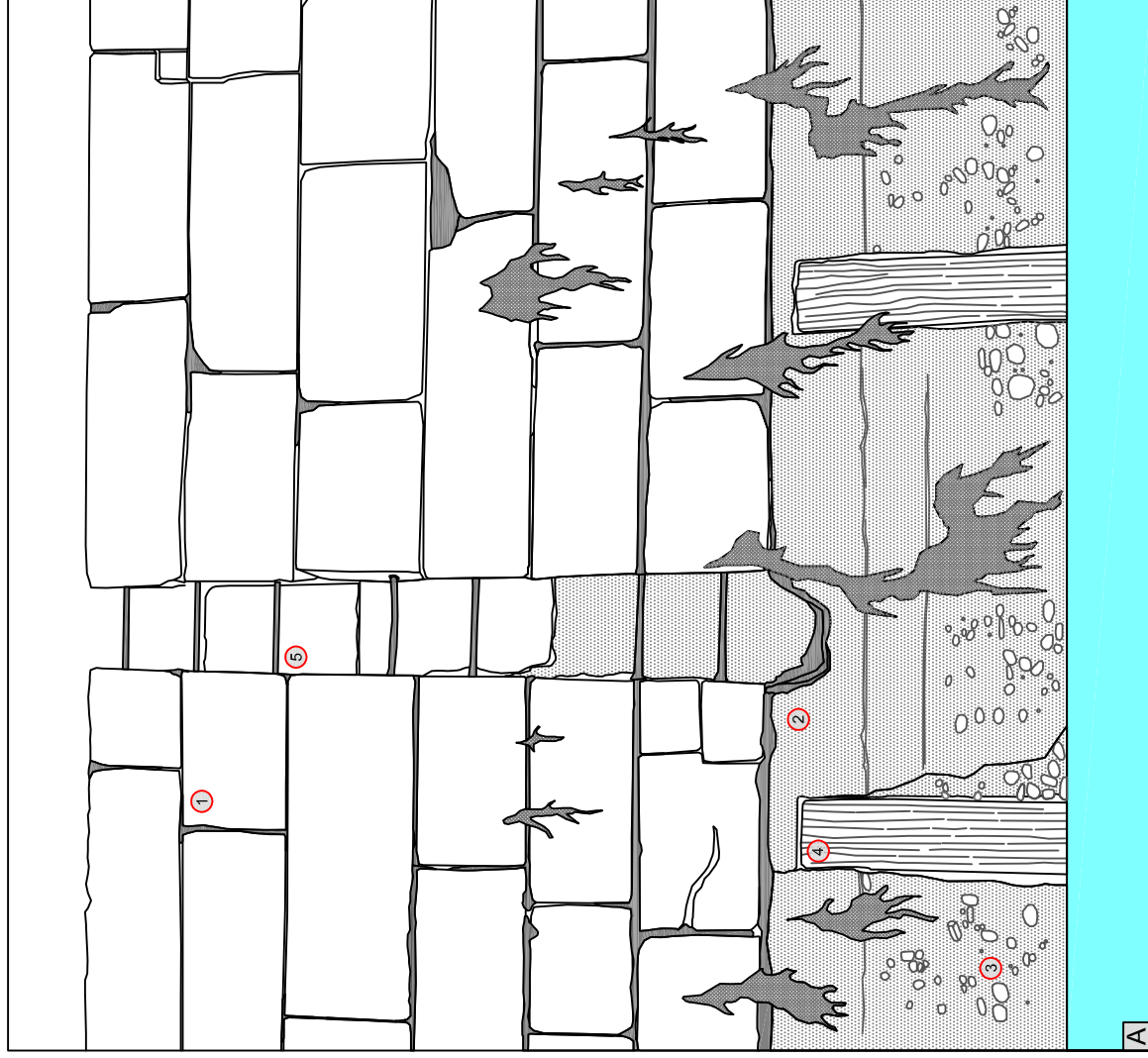
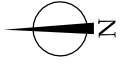

- 1 Neat-cut limestone masonry forming quay wall.
- 2 Cement render covering masonry from quay wall.
- 3 Poured concrete with pebble inclusions in matrix.
- 4 Greenheart timber piles used to reinforce the quay's foundations.
- 5 Wrought-iron ladder recessed into quay wall.
- 6 Rectangular silt-drain [masonry].



Notes
see Figure x for locations.

A4

Job/Exc No.
16D0053

Compiled by
R. Bangenter

CAD reference
Morrison's Island
Drawing No.
Figure 9

Client
Ryan Hanley Consulting Engineers

Project
UAIA, Morrison's Island Flood Alleviation Works

Title
Figure 9- A). Elevation showing masonry and recessed wrought-iron ladder access to river. Father Matthew Quay. B). Example of consolidation measures [Type 2] used along base of quay wall.

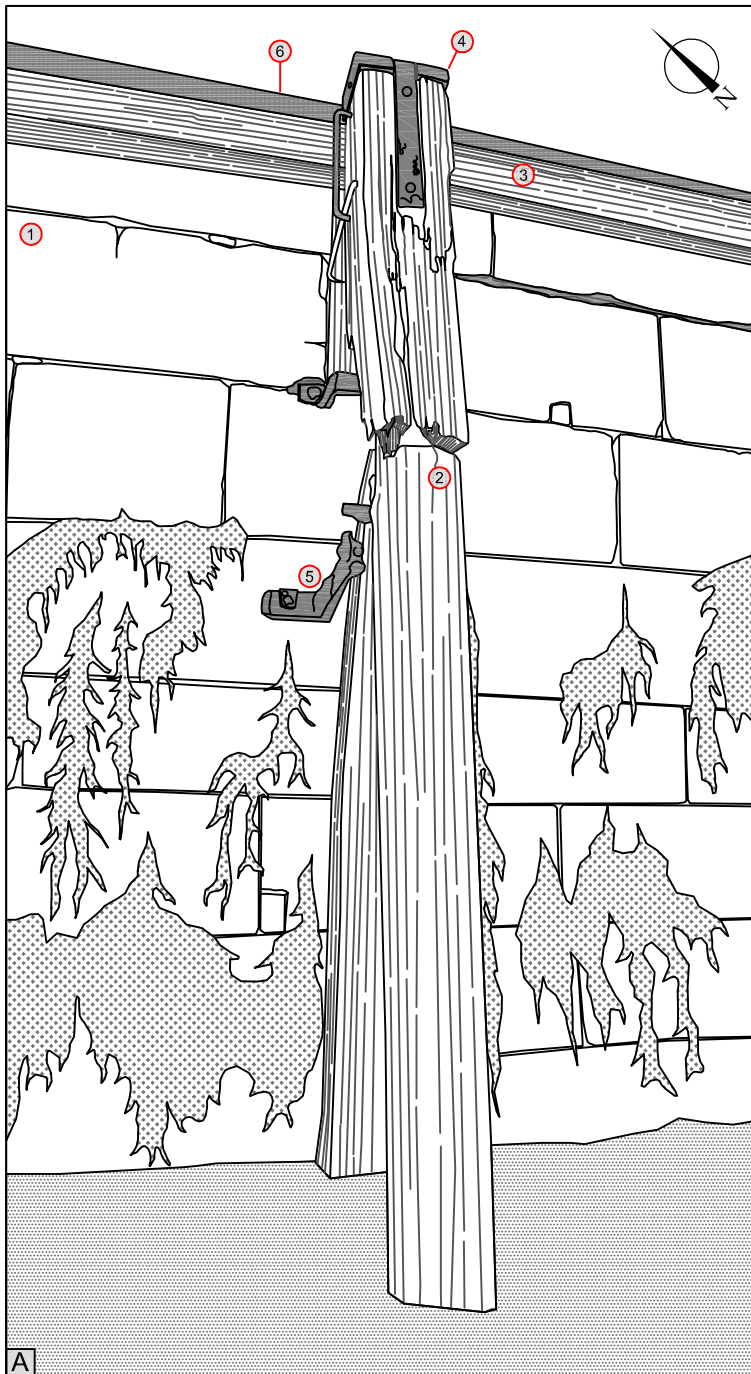
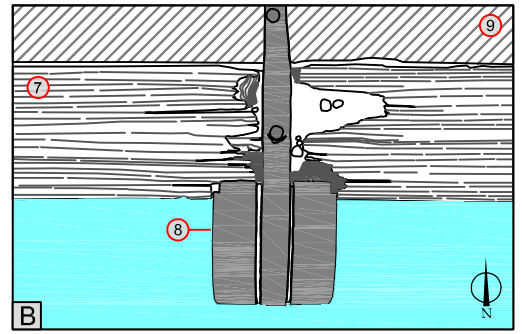

- ①— Neat-cut limestone masonry forming quay wall.
- ②— Composite greenheart timber fender.
- ③— Horizontal greenheart timber running east-west along top of quay.
- ④— Wrought-iron cap fastening to fender assemblage.
- ⑤— Wrought-iron brackets fastening timber to quay wall.
- ⑥— Poured mass-concrete located at street-level.
- ⑦— Horizontal greenheart timber [top view].
- ⑧— Wrought-iron fastening components [top view].
- ⑨— Poured mass-concrete [top view].

Notes
see Figure 8 for location.

Title
Figure 10-
A). Scaled isometric view of quay wall along Morrison's Quay, detailing one of the greenheart timber fenders that are present along much of its extent.
B). Aerial view of topmost part of timber fender.

A4



Client
Ryan Hanley Consulting Engineers

Project
UAIA, Morrison's Island Flood Alleviation Works

Job/Exc No.
16D0053

Compiled by
R.Bangertner

CAD reference
Morrison's_Island

Date
09.10.17

Scale
1:20

Drawing No.
Figure 10

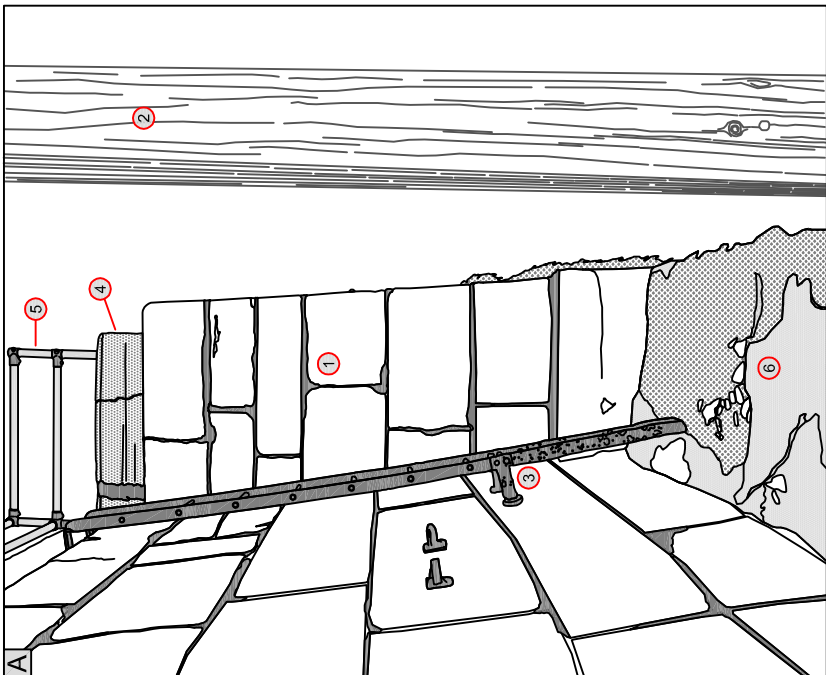

- ① Neat-cut limestone masonry forming quay wall.
- ② Vertical part of a composite greenheart timber fender.
- ③ Wrought-iron ladder fastened to quay wall.
- ④ Poured mass-concrete at street-level.
- ⑤ Galvanized steel railings.
- ⑥ Cement render at HWM.

- ① Neat-cut limestone masonry forming quay wall.
- ② Composite greenheart timber fender positioned at angle in quayside.
- ③ Horizontal timber shuttering.
- ④ Timber piles used to underpin quay wall.
- ⑤ Horizontal [greenheart] timber forming part of consolidation measures [Type 1] along the foundations of Father Mathew Quay.

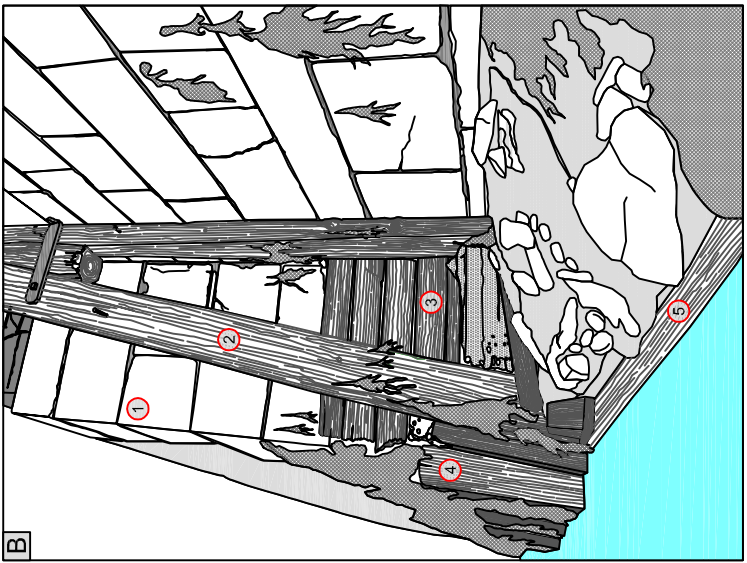

Notes
see Figure x for locations.

A4

Job/Exc No.
16D0053

Date
09.11.17

Compiled by
R. Bangerter

CAD reference
Morrison's Island
Drawing No.
Figure 11

Client
Ryan Hanley Consulting Engineers

Project
UAIA, Morrison's Island Floor Alleviation Works

Title
Figure 11- Scaled isometric views at two locations along Father Matthew Quay, as indicated in Figure 8.



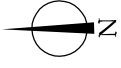

1—Neat-cut limestone masonry forming facade. 2—Consolidation of quay's foundations [Type 1]. 3—Active drain [masonry]. 4—Modern-built drain channel. 5—Flight of masonry river-access steps. 6—Poured mass-concrete at street-level.

Notes
see Figure 8 for location.

A4
Job/Exc No.
16D0053
Date
10.11.17

Compiled by
R.Bangerter
CAD reference
Morrison's_Island
Drawing No.
Figure 12

Client
Ryan Hanley Consulting Engineers
Project
UAIA, Morrison's Island Floor Alleviation Works

Title
Figure 12- Scaled isometric view showing quay wall and set of masonry river-access steps forming part of Morrison's Quay.





Plate 1: Nineteenth-century photograph showing down-stream side of Morrison's Quay and the newly reclaimed South Mall area (source: *Lawrence Collection*, www.corkpastandpresent.ie).

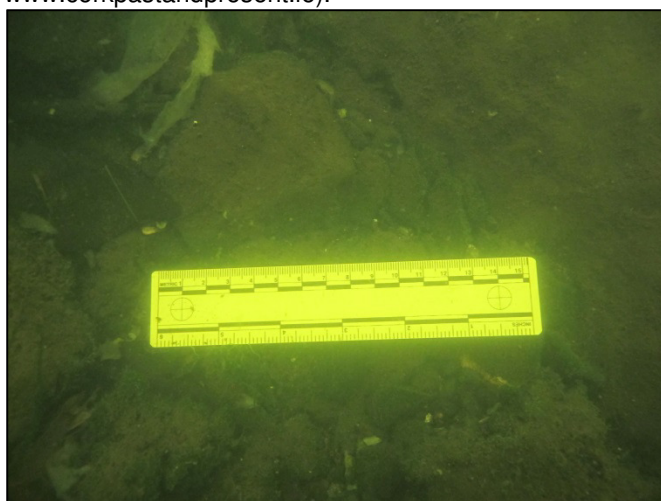

Plate 2: Underwater shot showing riverbed downstream of Parliament Bridge (150mm scale).

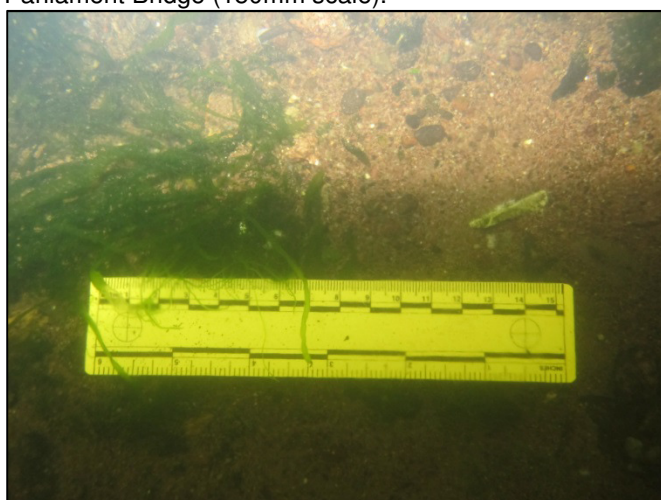

Plate 3: Underwater shot showing riverbed downstream of Trinity Footbridge (150mm scale).



Plate 4: Deposition on north side of channel, downstream of Trinity Footbridge (1m scale).



Plate 5: Northeast-facing view along upstream side of Morrison's Quay.



Plate 6: West-facing view of the South Channel showing upstream side of Trinity Footbridge.



Plate 7: Southwest-facing view of the river channel at Trinity Footbridge.



Plate 8: Northeast-facing view showing the fabric of the quay structure forming Father Matthew Quay and Morrison's Quay (1m scale).



Plate 9: Detail shot of masonry used to construct Morrison's Quay (1m scale).



Plate 10: Northwest-facing view Morrison's Quay showing timber piles (Type 1) and concrete used to underpin sections of Father Matthew Quay/Morrison's Quay (1m scale).



Plate 11: Example shot of timber piles (Type 1) used to underpin section of Father Matthew Quay/Morrison's Quay (1m scale).



Plate 12: Example shot of timber piles set flush to the quay wall along Father Matthew Quay (1m scale).

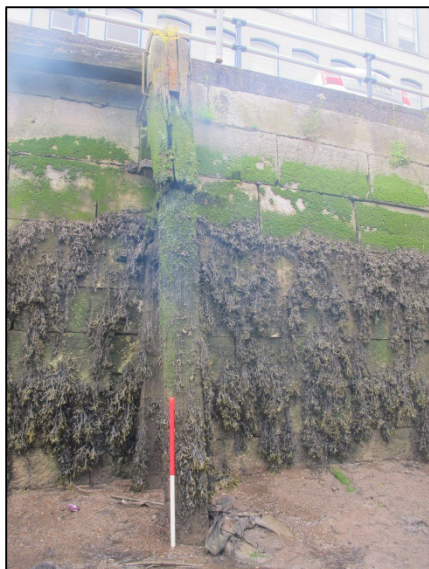

Plate 13: Example shot of timber fenders used along Father Matthew Quay/Morrison's Quay (1m scale).



Plate 14: Northwest-facing view along eastern half of Morrison's Quay; taken at Low Water (1m scale).

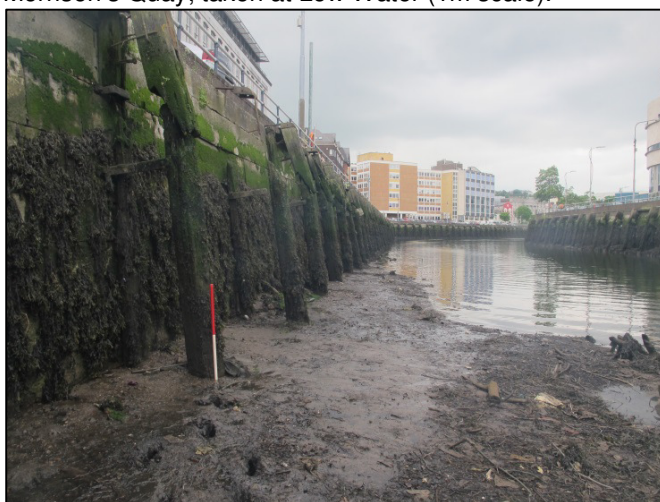

Plate 15: East-facing view along western half of Morrison's Quay; taken at Low Water (1m scale).



Plate 16: Example shot showing the top components of the timber fenders used along Father Matthew Quay/Morrison's Quay (1m scale).



Plate 17: Example shot showing top-view of timber fenders used along Father Matthew Quay/Morrison's Quay (1m scale).



Plate 18: Example shot showing one of three identical sets of river-access steps located along Father Matthew Quay/Morrison's Quay (1m scale).



Plate 19: Example shot showing one of three identical sets of river-access steps located along Father Matthew Quay/Morrison's Quay (1m scale).



Plate 20: Example shot showing one of the smaller rectangular drain features located along Father Matthew Quay/Morrison's Quay (1m scale).



Plate 21: Example shot showing one of the larger rectangular drain features located along Father Matthew Quay/Morrison's Quay (1m scale).

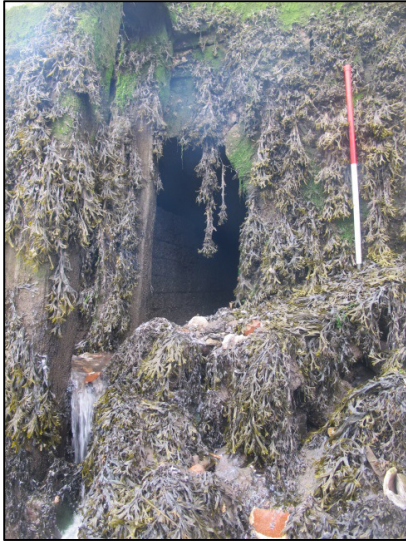

Plate 22: North-facing view of an arched-culvert located Morrison's Quay (1m scale).



Plate 23: Example shot of smaller type of iron mooring hoop associated with the river-access steps along Father Matthew Quay/Morrison's Quay.

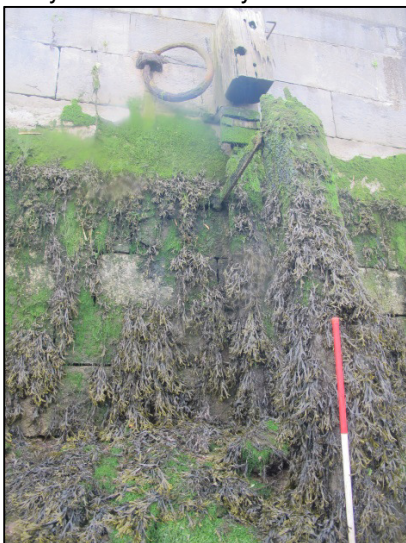

Plate 24: Example shot of larger type of iron mooring hoop located along Father Matthew Quay/Morrison's Quay (1m scale).



Plate 25: South-facing view of cast-iron mooring bollard located towards the southern end of Morrison's Quay (1m scale).



Plate 26: Example shot of one of the mooring bollards located at Lapp's Quay (1m scale).



Plate 27: West-facing view of downstream façade of Parliament Bridge.



Plate 28: West-facing view timber shuttering and bridge foundations located on north side of archway at Parliament Bridge (1m scale).



Plate 29: Drawing from the Illustrated London News (1843) depicting the original Anglesea Bridge of the 1830s (source: www.corkpastandpresent.ie).



Plate 30: Nineteenth-century photograph of the original Anglesea Bridge (source: Lawrence Collection, www.corkpastandpresnt.ie).

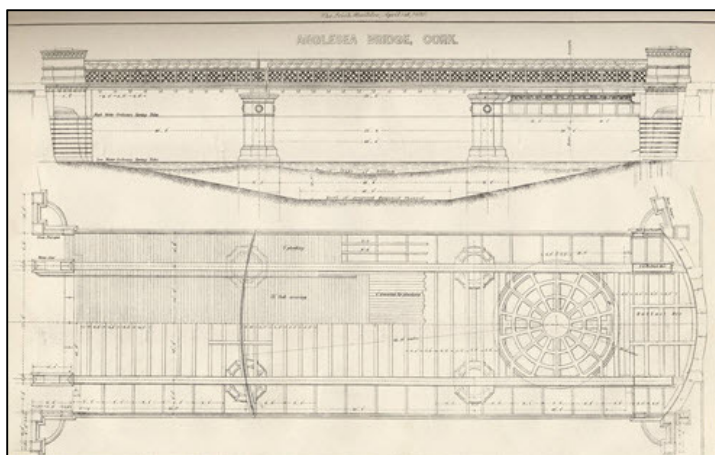

Plate 31: Nineteenth-century engineer's drawing of Anglesea Swivel-Bridge (source: [www. Corkpastandpresnt.ie](http://www.Corkpastandpresnt.ie))



Plate 32: Twentieth-century photograph of the iron swivel-bridge that replaced (1882) the earlier masonry structure forming Anglesea Bridge (source: Cork City Library).



Plate 33: East-facing view remains of southern bridge abutment beneath the existing Parnell Bridge (1m scale).



Plate 34: South-facing view showing masonry steps built as part of the original Parnell Bridge.



Plate 35: Northeast-facing view showing masonry forming a bridge abutment on the north side of the channel, located beneath the original Parnell Bridge (1m scale).



Plate 36: North-facing view upstream side of the modern Parnell Bridge built in 1971.

ADCO

Leading Maritime Archaeology

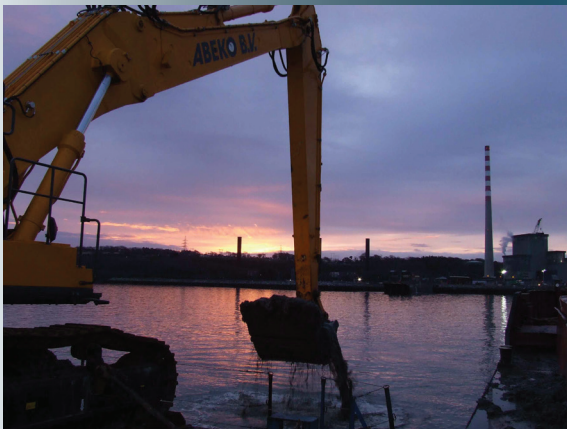
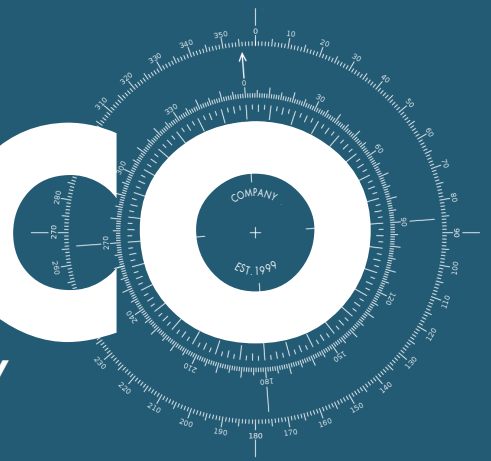

Providing effective underwater and land-based archaeological solutions since 1999.

Conducting intelligent diving and underwater/marine inspections for the civils and scientific sectors.

Specialised in marine geophysical data interpretation.

ADCO works closely with clients from project inception, through EIS, to full construction stages, delivering the highest quality effectively.

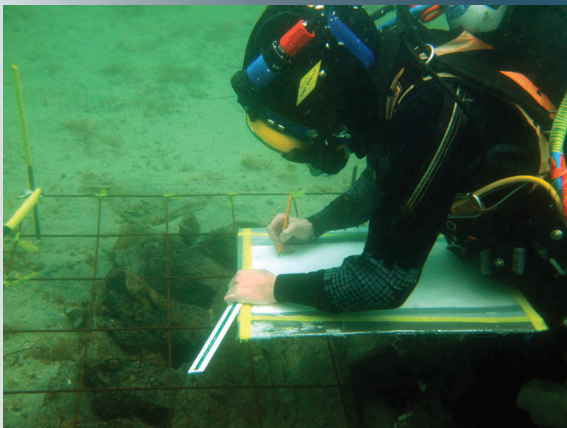

ADCO Ltd.
Church Terrace, Bray
Co. Wicklow, Ireland

www.adco-ie.com
info@adco-ie.com
+353 (0) 1 908 1541